

Contents

FORKLIFTS

Pag. 5	MOVEMENTS LEGEND - REF. A/0 MOD. 1603 ECO
Pag. 6	REF. A/1 MOD. 2008 ECO - A/2 MOD. 2208 ECO
Pag. 7	REF. A/3 MOD. 1515 ECO - A/4 MOD. 1815 ECO
Pag. 8	REF. A/5 MOD. 2215 ECO - A/6 MOD. 2515 ECO
Pag. 9	REF. A/7 MOD. 3215 ECO - A/8 MOD. 3815 ECO
Pag.10	REF. B/1 MOD. 2515 SUPER - B/2 MOD. 3215 SUPER
Pag.11	REF. B/3 MOD. 3220 SUPER - B/4 MOD. 3820 SUPER
Pag.12	REF. B/5 MOD. 4020 SUPER VT - C/1 MOD. 2510 TRIPLEX
Pag.13	REF. C/2 MOD. 2516 TRIPLEX - C/3 MOD. 3016 TRIPLEX
Pag.14	REF. C/4 MOD. 3316 TRIPLEX - C/5 MOD. 3616 TRIPLEX
Pag.15	REF. D/1 MOD. 2516 QUADRUPLEX - D/2 MOD. 3316 QUADRUPLEX
Pag.16	REF. D/3 MOD. 4016 QUADRUPLEX
Pag.17	ACCESSORIES
Pag.18	ACCESSORIES
Pag.19	ACCESSORIES
Pag.20	ACCESSORIES
Pag.21	ACCESSORIES
Pag.22	ELECTRO-HYDRAULIC DISTRIBUTOR WITH ONE-LEVER DEVICE
Pag.23	ELECTRO-HYDRAULIC DISTRIBUTOR WITH JOYSTICK CONTROL BOX
Pag.23	HYDRAULIC ELECTRODISTRIBUTOR WITH PROPORTIONAL CONTROL CONSOLLE
Pag.24	CONTAINER WITH HYDRAULIC OVERTURNING SYSTEM
Pag.25	HYDRAULIC SIDE TIPPER MECHANICAL BIN-HOLDER ARM
Pag.26	HYDRAULIC SIDE TIPPER HYDRAULIC BIN-HOLDER ARM
Pag.27	HYDRAULIC SIDE TIPPER WITH HYDRAULIC ARM AND FEM PLATE
Pag.28	HYDRAULIC SIDE TIPPER WITH 360° CONTINUOUS-BILATERAL ROTATION
Pag.29	HYDRAULIC SIDE TIPPER MRS
Pag.30	HYDRAULIC BUCKET FOR COUPLING
Pag.31	HYDRAULIC BUCKET TO BE APPLIED ON THE FORKS

BACKHOES

Pag.33	DIAGRAM AND TECHNICAL DATA
Pag.34	MOD. E 15
Pag.35	MOD. F19 - F20 - F23 - F24 - F25 - F28 - F30 - F36
Pag.37	MOD. E19 - E20 - E23 - E24 - E25 - E28 - E30 - E36
Pag.39	DIGGING BUCKET MOD. E15 - F/E19 - F/E20 - F/E23 - F/E24 - F/E25 - F/E28 - F/E 30 E MOD.F/E36
Pag.40	DITCHES CLEANING BUCKET MOD. E15 - F/E19 - F/E20 - F/E23 - F/E24 - F/E25 MOD. F/E28 - F/E30 - F/E 36
Pag.41	PIVOTING DITCHES CLEANING BUCKET MOD. F/E19 - F/E20 - F/E23 - F/E24 MOD. F/E25 - F/E28- F/E30 - F/E36
Pag.41	TRAPEZOID BUCKET MOD. E15 - F/E19 - F/E20 - F/E23 - F/E24 - F/E25 - F/E28 MOD. F/E30 - F/E36
Pag.42	GRIPPER MOD. F/E19 - F/E20 - F/E23 - F/E24 - F/E25 - F/E28- F/E30 - F/E36
Pag.43	BUCKET TEETH

Pag.44	PIN-TO-PIN QUICK COUPLERS
Pag.45	RAMDRILL WITH HELICAL DRILLS
Pag.46	EXTENSION RAMDRILL + SPARE PARTS
Pag.47	SCREEW WOOD SPLITTER
IN- AND OUT-TREE CULTIVATORS	
Pag.49	HYDRAULIC DISC CULTIVATOR WITH SIDE ARM
Pag.50	CULTIVATOR TO BE COMBINED WITH OTHERS EQUIPMENTS

COLOURS

Supplement for colours other than those official by
OUR CLIENTS ELS

PRICES EURO

109

FORKLIFTS

TECHNICAL DETAILS FOR FORKLIFTS

MODELS	H mm	I mm	N mm	X mm	L mm	T mm	F mm	Y kg
ECO 1603	1600	1600	—	—	495	300	200÷755	300
ECO 2008	2000	1760	1060	1940	420	380	570÷710	800
ECO 2208	2200	1860	1060	1940	420	380	570÷710	800
ECO1515	1500	1560	1060	1940	450	350	570÷710	1500
ECO 1815	1800	1660	1060	1940	450	350	570÷710	1500
ECO 2215	2200	1860	1060	1940	700	350	570÷710	1500
ECO 2515	2500	2090	1330	2530	700	350	570÷710	1500
ECO 3215	3200	2440	1330	2530	700	350	570÷710	1500
ECO 3815	3800	2740	1330	2530	700	350	570÷710	1500
SUP 2515	2500	2010	1330	2530	730	330	570÷710	1500
SUP 3215	3200	2360	1330	2530	730	330	570÷710	1500
SUP 3220	3200	2360	1330	2530	695	375	570÷710	2000
SUP 3820	3800	2710	1330	2530	695	375	570÷710	2000
SUP4020VT	4000	3030	1330	2530	695	375	570÷710	2000
TPX 2510	2500	1510	1060	1940	545	350	570÷710	1000
TPX 2516	2500	1510	1060	1940	785	350	570÷710	1600
TPX 3016	3000	1740	1060	1940	785	350	570÷710	1600
TPX 3316	3300	1840	1330	2530	785	350	570÷710	1600
TPX 3616	3600	1940	1330	2530	785	350	570÷710	1600
QDX2516VT	2500	1280	1060	1940	700	250	570÷710	1600
QDX3316VT	3300	1480	1060	1940	700	250	570÷710	1600
QDX4016VT	4000	1650	1060	1940	700	250	570÷710	1600
QDZ 2720	2700	1450	1060	1940	800	300	570÷710	2000
QDX 3220	3200	1550	1060	1940	800	300	570÷710	2000
QDX 3620	3600	1650	1330	2530	800	300	570÷710	2000
QDX 4020	4000	1750	1330	2530	800	300	570÷710	2000
QDX 4520	4500	1875	1330	2530	800	300	570÷710	2000
QDX 5220	5200	2050	1330	2530	800	300	570÷710	2000
QDX 6020	6000	2250	1330	2530	800	300	570÷710	2000

H= max. lifting height
 I= max channel height on the tractor
 N= minimum closing load holder
 X= maximum opening load holder
 L= forklift width
 T= ground clearance
 F= forks width
 Y= maximum capacity load

FORKLIFTS

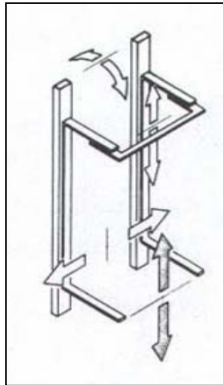

1 MOVEMENT

LIFT

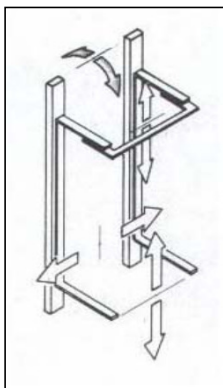

+

2 MOVEMENTS

TILT

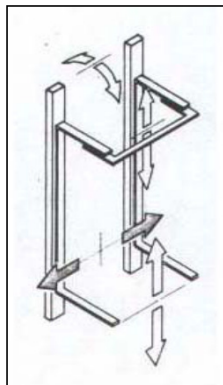

+

3 MOVEMENTS

SIDE SHIFT

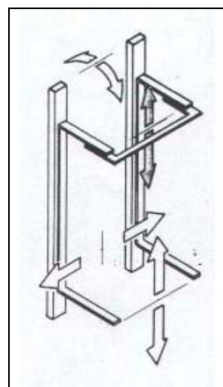

+

4 MOVEMENTS

LOAD HOLDER

REF. A/0 MOD. 1603 ECO

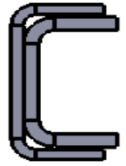

Characteristics

- Tested capacity load kg.300
- Lifting height mm.1600
- Channel height mm.1600
- Width mm.520
- Frame in steel with direct touch
- Forks in section , folding and adjustable in 4 positions
- No. 1 lifting chains
- No. 1 security chain
- 3° point linkage CAT 1
- **Distributor with 2 levers**

LIFT

- Double acting cylinder

TILT

- Cylinder stroke mm.100
- Ball joint on Ø mm.19 cylinder (grade 1)

SIDE SHIFT FORKS

MANUAL from mm. 120
 to mm. 650

PRICES EURO

Lift, tilt, side shift forks manual
 weight kg. 118

Hydraulic pump kit, gearbox, tank and hoses

REF. A/1 MOD. 2008 ECO



Characteristics

- Tested capacity load kg.800
- Lifting height mm.2000
- Channel height mounted on tractor mm.1760
- Width mm.450
- Frame in steel with direct touch
- Forks in section , folding and adjustable in 4 positions
- No. 2 lifting chains
- No. 1 security chain
- Sliding coils against usury and self-lubricating
- 3° point linkage CAT 1

LIFT

- Double acting cylinder

TILT

- Cylinder stroke mm.150
- Ball joint on Ø mm.19 cylinder (grade 1)

SIDE SHIFT mm.100 + mm.100

LOAD HOLDER

- Max ht. (fully open) mm.1940
- Max ht. (fully closed) mm.1060

Current pliable load holder

PRICES EURO

- 1 MOVEMENT weight kg.221.....
- 2 MOVEMENTS weight kg.235.....
- 3 MOVEMENTS weight kg.257
- 4 MOVEMENTS weight kg.339

Hydraulic pump kit, gearbox, tank and hoses

REF. A/2 MOD. 2208 ECO

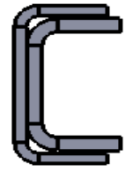

Characteristics

- Tested capacity load kg.800
- Lifting height mm.2200
- Channel height mounted on tractor mm.1860
- Width mm.450
- Frame in steel with direct touch
- Forks in section , folding and adjustable in 4 positions
- No. 2 lifting chains
- No. 1 security chain
- Sliding coils against usury and self-lubricating
- 3° point linkage CAT 1

LIFT

- Double acting cylinder

TILT

- Cylinder stroke mm.150
- Ball joint on Ø mm.19 cylinder (grade 1)

SIDE SHIFT mm.100 + mm.100

LOAD HOLDER

- Max ht. (fully open) mm.1940
- Max ht. (fully closed) mm.1060

Current pliable load holder

PRICES EURO

- 1 MOVEMENT weight kg. 228
- 2 MOVEMENTS weight kg.242
- 3 MOVEMENTS weight kg.259.....
- 4 MOVEMENTS weight kg.352.....

Hydraulic pump kit, gearbox, tank and hoses

REF. A/3 MOD. 1515 ECO



Characteristics

- Tested capacity load kg.1500
- Lifting height mm.1500
- Channel height mounted on tractor mm.1560
- Width mm.450
- Frame in steel with direct touch
- Forks in section , folding and adjustable in 4 positions
- No. 2 lifting chains
- No. 1 security chain
- Sliding coils against usury and self-lubricating
- 3° point linkage CAT 1

LIFT

- Double acting cylinder

TILT

- Cylinder stroke mm.150
- Ball joint on Ø mm.19 cylinder (grade 1)

SIDE SHIFT mm.100 + mm.100

LOAD HOLDER

- Max ht. (fully open) mm.1940
- Max ht. (fully closed) mm.1060

Current pliable load holder

PRICES EURO

1 MOVEMENT weight kg.245.....	2.419
2 MOVEMENTS weight kg.253	2.652
3 MOVEMENTS weight kg.289	3.102
4 MOVEMENTS weight kg.369	4.169

Hydraulic pump kit, gearbox, tank and hoses 835

REF. A/4 MOD. 1815 ECO

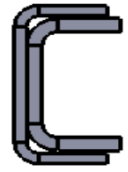

Characteristics

- Tested capacity load kg.1500
- Lifting height mm.1800
- Channel height mounted on tractor mm.1660
- Width mm.450
- Frame in steel with direct touch
- Forks in section , folding and adjustable in 4 positions
- No. 2 lifting chains
- No. 1 security chain
- Sliding coils against usury and self-lubricating
- 3° point linkage CAT 1

LIFT

- Double acting cylinder

TILT

- Cylinder stroke mm.150
- Ball joint on Ø mm.19 cylinder (grade 1)

SIDE SHIFT mm.100 + mm.100

LOAD HOLDER

- Max ht. (fully open) mm.1940
- Max ht. (fully closed) mm.1060

Current pliable load holder

PRICES EURO

1 MOVEMENT weight kg. 255.....
2 MOVEMENTS weight kg. 261.....
3 MOVEMENTS weight kg.300
4 MOVEMENTS weight kg.390

Hydraulic pump kit, gearbox, tank and hoses

REF. A/5 MOD. 2215 ECO



Characteristics

- Tested capacity load kg.1500
- Lifting height mm.2200
- Channel height mounted on tractor mm.1860
- Width mm.700
- Frame in steel with direct touch
- Forks in section , folding and adjustable in 4 positions
- No. 2 lifting chains
- No. 1 security chain
- Sliding coils against usury and self-lubricating
- 3° point linkage CAT 2

LIFT

- Double acting cylinder

TILT

- Cylinder stroke mm.150
- Ball joint on Ø mm.25,4 cylinder (grade 2)

SIDE SHIFT mm.100 + mm.100

LOAD HOLDER

- Max ht. (fully open) mm.1940
- Max ht. (fully closed) mm.1060

Current pliable load holder

PRICES EURO

1 MOVEMENT weight kg.305.....	2.903
2 MOVEMENTS weight kg.316.....	3.071
3 MOVEMENTS weight kg.341.....	3.559
4 MOVEMENTS weight kg.424.....	4.588

Hydraulic pump kit, gearbox, tank and hoses 835

REF. A/6 MOD. 2515 ECO

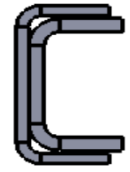

Characteristics

- Tested capacity load kg.1500
- Lifting height mm.2500
- Channel height mounted on tractor mm.2090
- Width mm.700
- Frame in steel with direct touch
- Forks in section , folding and adjustable in 4 positions
- No. 2 lifting chains
- No. 1 security chain
- Sliding coils against usury and self-lubricating
- 3° point linkage CAT 2

LIFT

- Double acting cylinder

TILT

- Cylinder stroke mm.150
- Ball joint on Ø mm.25,4 cylinder (grade 2)

SIDE SHIFT mm.100 + mm.100

LOAD HOLDER

- Max ht. (fully open) mm.2530
- Max ht. (fully closed) mm.1330

Current pliable load holder

PRICES EURO

1 MOVEMENT weight kg.318.....	
2 MOVEMENTS weight kg.326.....	
3 MOVEMENTS weight kg.352.....	
4 MOVEMENTS weight kg.452	

Hydraulic pump kit, gearbox, tank and hoses

REF. A/7 MOD. 3215 ECO



Characteristics

- Tested capacity load kg.1500
- Lifting height mm.3200
- Channel height mounted on tractor mm.2440
- Width mm.700
- Frame in steel with direct touch
- Forks in section , folding and adjustable in 4 positions
- No. 2 lifting chains
- No. 1 security chain
- Sliding coils against usury and self-lubricating
- 3° point linkage CAT 2

LIFT

- Double acting cylinder

TILT

- Cylinder stroke mm.150
- Ball joint on Ø mm.25,4 cylinder (grade 2)

SIDE SHIFT mm.100 + mm.100

LOAD HOLDER

- Max ht. (fully open) mm.2530
- Max ht. (fully closed) mm.1330

Current pliable load holder

PRICES EURO

1 MOVEMENT weight kg.327.....	3.142
2 MOVEMENTS weight kg.338.....	3.370
3 MOVEMENTS weight kg.395	3.802
4 MOVEMENTS weight kg.498.....	4.878

Hydraulic pump kit, gearbox, tank and hoses 835

REF. A/8 MOD. 3815 ECO

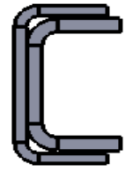

Characteristics

- Tested capacity load kg.1500
- Lifting height mm.3800
- Channel height mounted on tractor mm.2740
- Width mm.700
- Frame in steel with direct touch
- Forks in section , folding and adjustable in 4 positions
- No. 2 lifting chains
- No. 1 security chain
- Sliding coils against usury and self-lubricating
- 3° point linkage CAT 2

LIFT

- Double acting cylinder

TILT

- Cylinder stroke mm.150
- Ball joint on Ø mm.25,4 cylinder (grade 2)

SIDE SHIFT mm.100 + mm.100

LOAD HOLDER

- Max ht. (fully open) mm.2530
- Max ht. (fully closed) mm.1330

Current pliable load holder

PRICES EURO

1 MOVEMENT weight kg.372.....	
2 MOVEMENTS weight kg.384.....	
3 MOVEMENTS weight kg.442	
4 MOVEMENTS weight kg.508	

Hydraulic pump kit, gearbox, tank and hoses

REF. B/1 MOD. 2515 SUPER



Characteristics

- Tested capacity load kg.1500
- Lifting height mm.2500
- Channel height mounted on tractor mm.2010
- Width mm.730
- "U" frame in laminated steel with sliding on tempered rollers
- No. 2 lifting chains
- No. 1 security chain
- Sliding coils against usury and self-lubricating
- 3° point linkage CAT 2

- Folding steel forks and adjustable in 4 positions

LIFT

- Double acting cylinder

TILT

- Cylinder stroke mm.150
- Ball joint on Ø mm.25,4 cylinder (grade 2)

SIDE SHIFT mm.100 + mm.100

LOAD HOLDER

- Max ht. (fully open) mm.2530
- Max ht. (fully closed) mm.1330

Current pliable load holder

REF. B/2 MOD. 3215 SUPER



Characteristics

- Tested capacity load kg.1500
- Lifting height mm.3200
- Channel height mounted on tractor mm.2360
- Width mm.730
- "U" frame in laminated steel with sliding on tempered rollers
- No. 2 lifting chains
- No. 1 security chain
- Sliding coils against usury and self-lubricating
- 3° point linkage CAT 2

- Folding steel forks and adjustable in 4 positions

LIFT

- Double acting cylinder

TILT

- Cylinder stroke mm.150
- Ball joint on Ø mm.25,4 cylinder (grade 2)

SIDE SHIFT mm.100 + mm.100

LOAD HOLDER

- Max ht. (fully open) mm.2530
- Max ht. (fully closed) mm.1330

Current pliable load holder

PRICES EURO

1 MOVEMENT weight kg.332.....	3.490
2 MOVEMENTS weight kg.343	3.689
3 MOVEMENTS weight kg.410	4.170
4 MOVEMENTS weight kg.488	5.246

Hydraulic pump kit, gearbox, tank and hoses 835

PRICES EURO

1 MOVEMENT weight kg.336.....	
2 MOVEMENTS weight kg.347.....	
3 MOVEMENTS weight kg.414	
4 MOVEMENTS weight kg.581	

Hydraulic pump kit, gearbox, tank and hoses

REF. B/3 MOD. 3220 SUPER



Characteristics

- Tested capacity load kg.2000
- Lifting height mm.3200
- Channel height mounted on tractor mm.2360
- Width mm.730
- "U"and "H" frame in laminated steel with sliding on tempered rollers
- No. 2 lifting chains
- No. 1 security chain
- Sliding coils against usury and self-lubricating
- 3° point linkage CAT 2

- Folding steel forks and adjustable in 4 positions

LIFT

- Double acting cylinder

TILT

- Cylinder stroke mm.150
- Ball joint on Ø mm.25,4 cylinder (grade 2)

SIDE SHIFT mm.100 + mm.100

LOAD HOLDER

- Max ht. (fully open) mm.2530
- Max ht. (fully closed) mm.1330

Current pliable load holder

REF. B/4 MOD. 3820 SUPER



Characteristics

- Tested capacity load kg.2000
- Lifting height mm.3800
- Channel height mounted on tractor mm.2710
- Width mm.730
- "U"and "H" frame in laminated steel with sliding on tempered rollers
- No. 2 lifting chains
- No. 1 security chain
- Sliding coils against usury and self-lubricating
- 3° point linkage CAT 2

- Folding steel forks and adjustable in 4 positions

LIFT

- Double acting cylinder

TILT

- Cylinder stroke mm.150
- Ball joint on Ø mm.25,4 cylinder (grade 2)

SIDE SHIFT mm.100 + mm.100

LOAD HOLDER

- Max ht. (fully open) mm.2530
- Max ht. (fully closed) mm.1330

Current pliable load holder

PRICES EURO

1 MOVEMENT weight kg. 650	4.598
2 MOVEMENTS weight kg. 660	4.848
3 MOVEMENTS weight kg. 715	5.424
4 MOVEMENTS weight kg. 750	6.504

Hydraulic pump kit, gearbox, tank and hoses 835

PRICES EURO

1 MOVEMENT weight kg. 690	
2 MOVEMENTS weight kg. 710	
3 MOVEMENTS weight kg. 755	
4 MOVEMENTS weight kg. 790	

Hydraulic pump kit, gearbox, tank and hoses

REF. B/5 MOD. 4020 SUPER VT

***** SPECIAL MODEL *****

Model available only with side mounted lift cylinders



Characteristics

- Tested capacity load kg.2000
- Lifting height mm.4000
- Channel height mounted on tractor mm.3030
- Width mm. 710
- "U"and "H" frame in laminated steel with sliding on tempered rollers
- No. 2 lifting chains type fleyer
- No. 1 security chain
- Sliding coils against usury and self-lubricating
- 3° point linkage CAT 2

- Side-mounted lift cylinders (full visibility)

- Folding steel forks and adjustable in 4 positions

LIFT

- Double acting cylinder

TILT

- Cylinder stroke mm.150
- Ball joint on Ø mm.25,4 cylinder (grade 2)

SIDE SHIFT mm.100 + mm.100

LOAD HOLDER

- Max ht. (fully open) mm.2530
- Max ht. (fully closed) mm.1330

Current pliable load holder

PRICES EURO

1 MOVEMENT weight kg.700	5.701
2 MOVEMENTS weight kg.730.....	6.233
3 MOVEMENTS weight kg.770	7.080
4 MOVEMENTS weight kg.810	8.063

Hydraulic pump kit, gearbox, tank and hoses 835

REF. C/1 MOD. 2510 TRIPLEX



Characteristics

- Tested capacity load kg.1000
- Lifting height mm.2500
- Channel height mounted on tractor mm.1510
- Width mm.540
- Triple "U" frame in laminated steel with sliding on bearings with lateral contrast coil.
- No. 3 lifting chains type fleyer
- No. 1 security chain
- Sliding coils against usury and self-lubricating
- 3° point linkage CAT 1
- mm. 150 lifting without increase of overall height

- Forks in section , folding and adjustable in 4 || positions

LIFT

- Double acting cylinder

TILT

- Cylinder stroke mm.150
- Ball joint on Ø mm.19 cylinder (grade 1)

SIDE SHIFT mm.100 + mm.100

LOAD HOLDER

- Max ht. (fully open) mm.1940
- Max ht. (fully closed) mm.1060

Current pliable load holder

PRICES EURO

1 MOVEMENT weight kg.275.....	
2 MOVEMENTS weight kg.287.....	
3 MOVEMENTS weight kg.322	
4 MOVEMENTS weight kg.401.....	

Hydraulic pump kit, gearbox, tank and hoses

REF. C/2 MOD. 2516 TRIPLEX

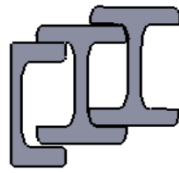

Characteristics

- Tested capacity load kg.1600
- Lifting height mm.2500
- Channel height mounted on tractor mm.1510
- Width mm.790
- "U" and double "H" frame in laminated steel with sliding on bearings with lateral contrast coil.
- No. 4 lifting chains type fleyer
- No. 1 security chain
- Sliding coils against usury and self-lubricating
- 3° point linkage CAT 2
- mm. 60 lifting without increase of overall height
- **Folding steel forks and adjustable in 4**

positions

LIFT

- **Double acting cylinder**

TILT

- Cylinder stroke mm.150
- Ball joint on Ø mm.25,4 cylinder (grade 2)

SIDE SHIFT mm.100 + mm.100

LOAD HOLDER

- Max ht. (fully open) mm.1940
- Max ht. (fully closed) mm.1060

Current pliable load holder

PRICES EURO

1 MOVEMENT weight kg.448.....	4.104
2 MOVEMENTS weight kg.460.....	4.302
3 MOVEMENTS weight kg.482	4.785
4 MOVEMENTS weight kg.555	5.855
Hydraulic pump kit, gearbox, tank and hoses	835

REF. C/3 MOD. 3016 TRIPLEX

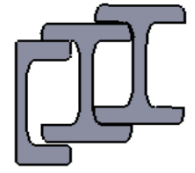

Characteristics

- Tested capacity load kg.1600
- Lifting height mm.3000
- Channel height mounted on tractor mm.1740
- Width mm.790
- "U" and double "H" frame in laminated steel with sliding on bearings with lateral contrast coil.
- No. 4 lifting chains type fleyer
- No. 1 security chain
- Sliding coils against usury and self-lubricating
- 3° point linkage CAT 2
- mm. 60 lifting without increase of overall height
- **Folding steel forks and adjustable in 4**

positions

LIFT

- **Double acting cylinder**

TILT

- Cylinder stroke mm.150
- Ball joint on Ø mm.25,4 cylinder (grade 2)

SIDE SHIFT mm.100 + mm.100

LOAD HOLDER

- Max ht. (fully open) mm.1940
- Max ht. (fully closed) mm.1060

Current pliable load holder

PRICES EURO

1 MOVEMENT weight kg.452.....	
2 MOVEMENTS weight kg.465.....	
3 MOVEMENTS weight kg.499	
4 MOVEMENTS weight kg.577	
Hydraulic pump kit, gearbox, tank and hoses	

REF. C/4 MOD. 3316 TRIPLEX

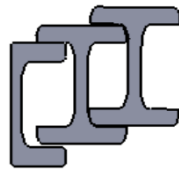

Characteristics

- Tested capacity load kg.1600
- Lifting height mm.3300
- Channel height mounted on tractor mm.1840
- Width mm.790
- "U" and double "H" frame in laminated steel with sliding on bearings with lateral contrast coil.
- No. 4 lifting chains type fleyer
- No. 1 security chain
- Sliding coils against usury and self-lubricating
- 3° point linkage CAT 2
- mm. 60 lifting without increase of overall height
- **Folding steel forks and adjustable in 4**

positions

LIFT

- **Double acting cylinder**

TILT

- Cylinder stroke mm.150
- Ball joint on Ø mm.25,4 cylinder (grade 2)

SIDE SHIFT mm.100 + mm.100

LOAD HOLDER

- Max ht. (fully open) mm.2530
- Max ht. (fully closed) mm.1330

Current pliable load holder

PRICES EURO

1 MOVEMENT weight kg.483.....	4.443
2 MOVEMENTS weight kg.495.....	4.768
3 MOVEMENTS weight kg.529.....	5.251
4 MOVEMENTS weight kg.630	6.214
Hydraulic pump kit, gearbox, tank and hoses	835

REF. C/5 MOD. 3616 TRIPLEX

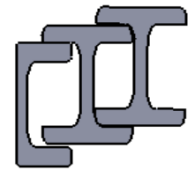

Characteristics

- Tested capacity load kg.1600
- Lifting height mm.3600
- Channel height mounted on tractor mm.1940
- Width mm.790
- "U" and double "H" frame in laminated steel with sliding on bearings with lateral contrast coil.
- No. 4 lifting chains type fleyer
- No. 1 security chain
- Sliding coils against usury and self-lubricating
- 3° point linkage CAT 2
- mm. 60 lifting without increase of overall height
- **Folding steel forks and adjustable in 4**

positions

LIFT

- **Double acting cylinder**

TILT

- Cylinder stroke mm.150
- Ball joint on Ø mm.25,4 cylinder (grade 2)

SIDE SHIFT mm.100 + mm.100

LOAD HOLDER

- Max ht. (fully open) mm.2530
- Max ht. (fully closed) mm.1330

Current pliable load holder

PRICES EURO

1 MOVEMENT weight kg.519	
2 MOVEMENTS weight kg.533.....	
3 MOVEMENTS weight kg.549.....	
4 MOVEMENTS weight kg.648	
Hydraulic pump kit, gearbox, tank and hoses	

REF. D/1 MOD. 2516VT QUADRUPLEX

***** SPECIAL MODEL*****

Model supplied with two lift lateral cylinders

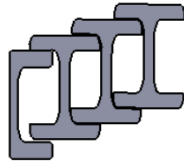

Characteristics

- Tested capacity load kg.1600
- Lifting height mm.2500
- Channel height mounted on tractor mm.1280
- Width mm.700
- "U" and triple "H" frame in laminated steel with sliding on bearings with lateral contrast coil.
- No. 4 lifting chains type fleyer
- No. 1 security chain
- Sliding coils against usury and self-lubricating
- 3° point linkage CAT 2
- mm. 200 lifting without increase of overall height

- Side-mounted lift cylinders (full visibility)

- Folding steel forks and adjustable in 4 positions

LIFT

- Double acting cylinder

TILT

- Cylinder stroke mm.150
- Ball joint on Ø mm.25,4 cylinder (grade 2)

SIDE SHIFT mm.100 + mm.100

LOAD HOLDER

- Max ht. (fully open) mm.1950
- Max ht. (fully closed) mm.1100

Current pliable load holder

PRICES EURO

- 1 MOVEMENT
- 2 MOVEMENTS
- 3 MOVEMENTS
- 4 MOVEMENTS

Hydraulic pump kit, gearbox, tank and hoses

REF. D/2 MOD. 3316VT QUADRUPLEX

***** SPECIAL MODEL*****

Model supplied with two lift lateral cylinders

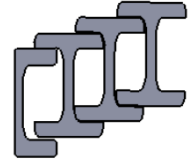

Characteristics

- Tested capacity load kg.1600
- Lifting height mm.3300
- Channel height mounted on tractor mm.1480
- Width mm.700
- "U" and triple "H" frame in laminated steel with sliding on bearings with lateral contrast coil.
- No. 4 lifting chains type fleyer
- No. 1 security chain
- Sliding coils against usury and self-lubricating
- 3° point linkage CAT 2
- mm. 200 lifting without increase of overall height

- Side-mounted lift cylinders (full visibility)

- Folding steel forks and adjustable in 4 positions

LIFT

- Double acting cylinder

TILT

- Cylinder stroke mm.150
- Ball joint on Ø mm.25,4 cylinder (grade 2)

SIDE SHIFT mm.100 + mm.100

LOAD HOLDER

- Max ht. (fully open) mm.2450
- Max ht. (fully closed) mm.1350

Current pliable load holder

PRICES EURO

- 1 MOVEMENT
- 2 MOVEMENTS
- 3 MOVEMENTS
- 4 MOVEMENTS

Hydraulic pump kit, gearbox, tank and hoses

REF. D/3 MOD. 4016VT QUADRUPLEX

***** SPECIAL MODEL *****

Model supplied with two lift lateral cylinders

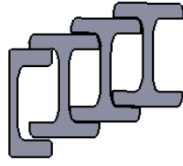

Characteristics

- Tested capacity load kg.1600
- Lifting height mm.4000
- Channel height mounted on tractor mm.1650
- Width mm.700
- "U" and triple "H" frame in laminated steel with sliding on bearings with lateral contrast coil.
- No. 4 lifting chains type fleyer
- No. 1 security chain
- Sliding coils against usury and self-lubricating
- 3° point linkage CAT 2
- mm. 200 lifting without increase of overall height

- Side-mounted lift cylinders

(full visibility)

- Folding steel forks and adjustable in 4 positions

LIFT

- **Double acting cylinder**

TILT

- Cylinder stroke mm.150
- Ball joint on Ø mm.25,4 cylinder (grade 2)

SIDE SHIFT mm.100 + mm.100

LOAD HOLDER

- Max ht. (fully open) mm.2450
- Max ht. (fully closed) mm.1350

Current pliable load holder

PRICES EURO

- 1 MOVEMENT
- 2 MOVEMENTS
- 3 MOVEMENTS
- 4 MOVEMENTS

Hydraulic pump kit, gearbox, tank and hoses

ACCESSORIES	PRICES EURO
<ul style="list-style-type: none"> - Pair of bale forks Ø 36 x 1400 mm with bushes - Pair of bale forks Ø 36 x 1400 mm with attack FEM 2 fix - Pair of bale forks Ø 36 x 1400 mm with attack FEM 2 flexible - Pair of bale forks Ø 42 x 1400 mm with bushes - Pair of bale forks Ø 42 x 1400 mm with attack FEM 2 fix - Pair of bale forks Ø 42 x 1400 mm with attack FEM 2 flexible 	

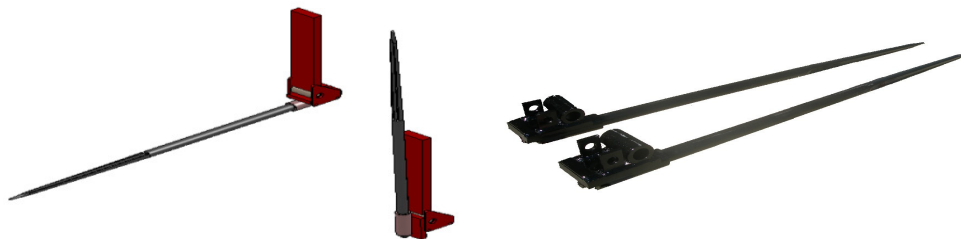

ACCESSORIES	PRICES EURO
<ul style="list-style-type: none"> - Supplement for one pair ECO/TRIPLEX 2510 with working length of 1200 mm. - Supplement for one pair SUPER/TRIPLEX with working length of 1200 mm.capacity load kg.1600 - Supplement for one pair SUPER/TRIPLEX with working length of 1200 mm.capacity load kg.2000 	

SPARE PARTS	PRICES EURO
<ul style="list-style-type: none"> - Pair forks ECO 2008-2208 with a working length of 1000 mm - Pair forks ECO / TPX 2510 with a working length of 1000 mm - Pair forks SUPER / TPX with a working length of 1000 mm capacity load kg. 1600 - Pair forks SUPER / TPX FEM with a working length of 1000 mm capacity load kg. 2000 - Pair forks FEM with a working length of 1000 mm capacity load kg. 1600 - Pair forks FEM with a working length of 1200 mm capacity load kg. 1600 - Pair forks FEM with a working length of 1000 mm capacity load kg. 2000 - Pair forks FEM with a working length of 1200 mm capacity load kg. 2000 	
**THE PRICES ABOVE-MENTIONED REFER TO FORKS SUPPLIED SEPARATELY.	

ACCESSORIES

- Supplement for one pair adjustable and folding steel forks with capacity load max 1600 kg.

- Supplement for one pair adjustable and folding steel forks with capacity load max 2000 kg.

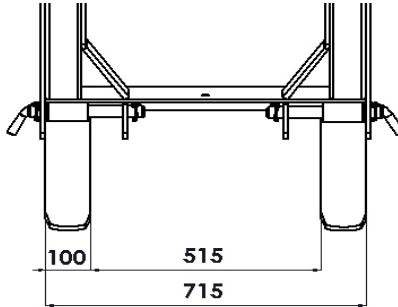

PRICES EURO

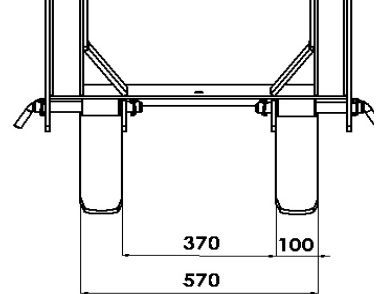

ACCESSORIES

- Supplement for one pair adjustable FEM standard forks mm.1000, capacity load max.1600 kg.

- Supplement for one pair adjustable FEM standard forks mm.1200, capacity load max.1600 kg.

- Supplement for one pair adjustable FEM standard forks mm.1000, capacity load max.2000 kg.

- Supplement for one pair adjustable FEM standard forks mm.1200, capacity load max.2000 kg.

- Supplement for one pair FEM forks mm.1000 adjustable and folding with capacity load max.1600 kg.

- Supplement for one pair FEM forks mm.1200 adjustable and folding with capacity load max.1600 kg.

- Supplement for one pair FEM forks mm.1000 adjustable and folding with capacity load max.2000 kg.

- Supplement for one pair FEM forks mm.1200 adjustable and folding with capacity load max.2000 kg.

- Supplement for one pair FEM fork-holder plates mm.1000

- Supplement for one pair FEM fork-holder plates mm.1200

**FOR APPLICATION ON FORKLIFTS IT IS NECESSARY TO COMBINE PLATES AND FORKS.

PRICES EURO

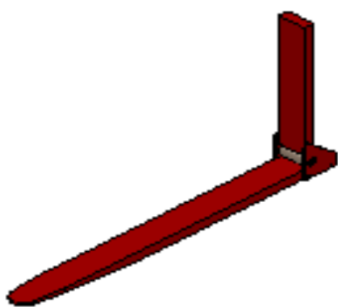

ACCESSORIES	PRICES EURO
<ul style="list-style-type: none"> -Supplement for double-side mounted lift cylinders (total visibility) - for ECO, SUPER and TRIPLEX models 	



ACCESSORIES	PRICES EURO
<ul style="list-style-type: none"> -Supplement for double cylinders in load holder(suggested in model with total visibility with double lift cylinders) 	

ACCESSORIES	PRICES EURO
<ul style="list-style-type: none"> - Supplement for front mounting connection with two tilt cylinders (hoses extension excluded) - Supplement for hydraulic support-foot 	

ACCESSORIES	LENGTH MM.	PRICES EURO
<ul style="list-style-type: none"> -Flexible cable distributor-shifting (one for each lever) -Manipulator for flexible cable (one for each cable) 	1500 2000 2500 4000	

ACCESSORIES	PRICES EURO
<ul style="list-style-type: none"> -Supplement for load holder double cylinders with extraelevation max. height mm. 2800 min. 1100 -Supplement lifting without increase of overall height cm. 20 with single acting lifting cylinder -Supplement predisposition attacks couple rapid -Deduction case-holding press -Supplement for different clearance from the ground 	

ACCESSORIES

PRICES EURO

-Supplement for binsholder bar screwed



ACCESSORIES

PRICES EURO

-Supplement for arresting hook in load holder

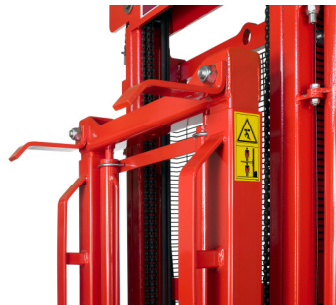

ACCESSORIES

PRICES EURO

- Threaded extension for tilt cylinder mm.100
- Threaded extension for tilt cylinder mm.150
- Threaded extension for tilt cylinder mm.200



ACCESSORIES	PRICES EURO
<ul style="list-style-type: none"> - Supplement for additional lever on the distributor - Supplement for couple of alimentation hoses' additional lever - Supplement for hydraulic predisposition with bracket and quick couplers F1/2 in addition to couple of alimentation hoses for additional lever with or without distributor - Supplement for kit female quick coupling 1/4 for additional lever <p><u>The supplements listed below are recommended when the forklift is equipped without distributor</u></p> <p style="padding-left: 20px;">Supplement for longer hoses</p> <ul style="list-style-type: none"> - for forklift 1 movement each meter - for forklift 2 movements each meter - for forklift 3 movements each meter - for forklift 4 movements each meter <p>- Supplement for kit quick couplings M1/2" + longer hoses cm 50 for the connections of the tubes directly to the tractor oil.</p> <ul style="list-style-type: none"> - For forklift with 1 movement - For forklift with 2 movements - For forklift with 3 movements - For forklift with 4 movements 	

DEDUCTION DISTRIBUTOR COST if the machine is requested without distributor	LIST PRICES
<p>Deduction for no distributor with 1 lever</p> <p>Deduction for no distributor with 2 levers</p> <p>Deduction for no distributor with 3 levers</p> <p>Deduction for no distributor with 4 levers</p> <p>Usually this deduction provides to add quick couplings Kit + longer hoses of mt. 1, 5 to the prices above-mentioned to specify when passing the order.</p>	

ACCESSORIES	PRICES EURO
<ul style="list-style-type: none"> - Supplement for bracket with quick couplings F1/2 - Supplement support extended carriages forks - Deduction for no cylinder 3° point (tilt) - Price increasing for liftarms connection CAT 1 - Price increasing for liftarms connection CAT 2 - Supplement holder for one bin with a couple of arresting mechanical hooks -Min. closing mm. 350 	

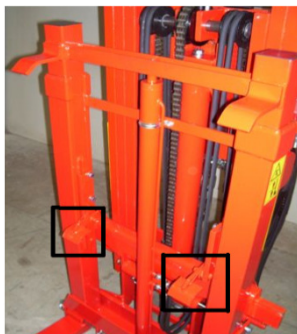

ELECTRO-HYDRAULIC DISTRIBUTOR WITH ONE-LEVER DEVICE MOUNTED ON TRACTOR DISTRIBUTOR

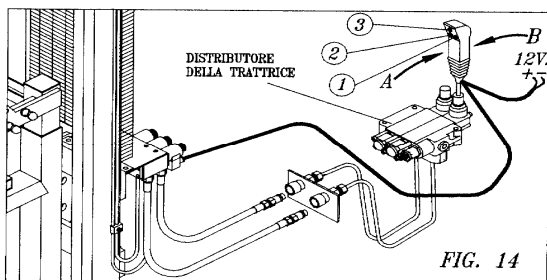

There is an alternative to the usual hand levers distributor: It is possible E.L.S. agricultural elevators work by means of a one-lever device with electric function to be mounted on the lever of the tractor double effect distributor used for elevator working.

For working, you need:

- The tractor must be equipped with a double effect distributor

- The hydraulic connection must occur by means of the tractor hydraulic implement and not by means of the independent hydraulic set pump-multiplier

- The elevator must be equipped with a special distributor with electrovalves instead of the usual hand levers distributor

- Make a simple electric connection (see draw X) to stoke the device.



The one-lever device offers the advantage to allow all movements performances by means of one lever only, selecting the movements by means of a push-button, with the exception of lift movement that happens moving the lever without pushing any button.

LIFTING movement, for forks lifting up and down, happens moving the lever towards A-B (see draw Y) without pushing any button.

For the other movements below mentioned, you must push the button according the following diagram and at the same time moving the lever.

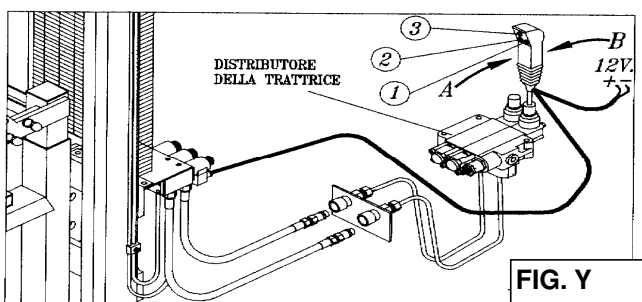

- 1 TILT**
Elevator moving backwards or forwards
- 2 SIDE MOVEMENT**
Side shift
- 3 LOAD HOLDER**
It controls load holder up and down

IF IT IS SEPARATELY SUPPLIED

- 2 electrovalves one-lever control box device "cobra" for 3 movements forklift
- 3 electrovalves one-lever control box device "cobra" for 4 movements forklift

PRICES

IF SUPPLIED TOGETHER WITH THE AGRICULTURAL FORKLIFT, INSTEAD OF THE USUAL HAND-LEVERS

- **SUPPLEMENT** for electric distributor with 2 electrovalves for 3 movements elevators, one-lever cobra included
- **SUPPLEMENT** for electric distributor with 3 electrovalves for 4 movements elevators, one-lever cobra included

PRICES

ELECTRO-HYDRAULIC DISTRIBUTOR WITH CONTROL BOX

The electro-hydraulic distributor allows to operate by a joystick all the forklift's movements. The joystick box can be easily positioned anywhere as per customer requirements.

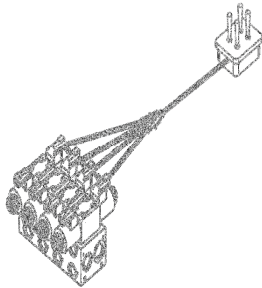

IF IT IS SEPARATELY SUPPLIED

- Distributor with 3 movements for forklift including wiring joystick control box
- Distributor with 4 movements for forklift including wiring joystick control box

PRICE
EURO

IF SUPPLIED TOGETHER WITH THE AGRICULTURAL FORKLIFT, INSTEAD OF THE USUAL HAND-LEVERS

- SUPPLEMENT for 3 movements distributor for forklift, wiring joystick control box included
- SUPPLEMENT for 4 movements distributor for forklift, wiring joystick control box included

PRICE
EURO

HYDRAULIC ELECTRODISTRIBUTOR WITH PROPORTIONAL CONTROL CONSOLE

The hydraulic electro distributor with proportional control console allows the proportional control of forklift's movements. The proportional control console can be easily positioned anywhere as for customer requirements.

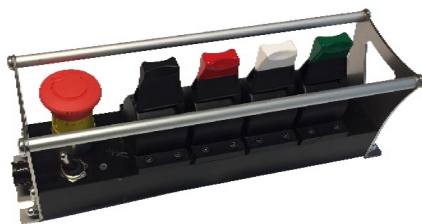

IF IT IS SEPARATELY SUPPLIED

- Distributor with 3 movements for forklift including wiring control console
- Distributor with 4 movements for forklift including wiring control console

PRICE
EURO

IF SUPPLIED TOGETHER WITH THE AGRICULTURAL FORKLIFT, INSTEAD OF THE USUAL HAND-LEVERS

- SUPPLEMENT for 3 movements distributor for forklift, including wiring control console
- SUPPLEMENT for 4 movements distributor for forklift, including wiring control console

PRICE
EURO

CONTAINER WITH HYDRAULIC OVERTURNING SYSTEM

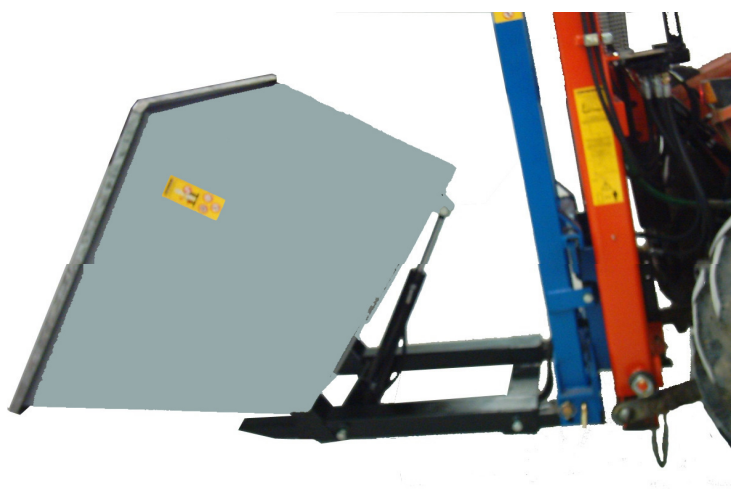

SHEET-METAL CONTAINER

Capacity Lt. 840

STEEL-METAL CONTAINER

Capacity Lt. 840

weight Kg. 163

weight Kg. 163

PRICES EURO

HYDRAULIC SIDE TIPPER WITH MECHANICAL BIN-HOLDER ARM



Suitable for any agricultural and industrial forklift

- Max nominal capacity load kg.1500
- Max overturning capacity load kg.700
- Closing min. 680 mm. max. 980 mm.
- Weight kg.265

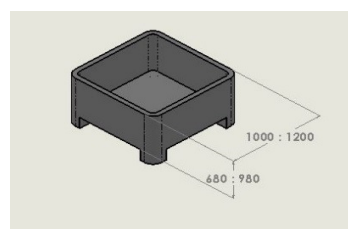

- Supplement for attachment FEM 2
- Supplement for attachment FEM 3
- Supplement for double attachment FEM 2 and FEM 3
- Supplement for attachment on tractor agricultural forklift

- * Pichforkable shoe-homs
- * Supplement for folding forks

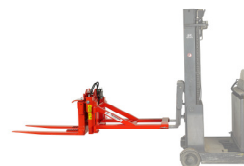

PRICES EURO

HYDRAULIC SIDE TIPPER WITH HYDRAULIC BIN-HOLDER ARM



Suitable for any agricultural and industrial forklift
 With sequence valve, which allows blocking and overturning with a single lever

- Max nominal capacity load kg.1500
- Max overturning capacity load kg.700
- Closing min. 530 mm. max. 780 mm.
- Weight kg.285

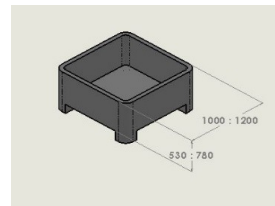

- Max nominal capacity load kg.1500
- Max overturning capacity load kg.700
- Closing min. 780 mm. max. 1000 mm.
- Weight kg.293

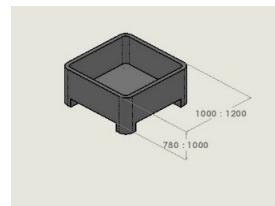

- Max nominal capacity load kg.1500
- Max overturning capacity load kg.700
- Closing min. 530 mm. max. 1000 mm.
- Weight kg.305

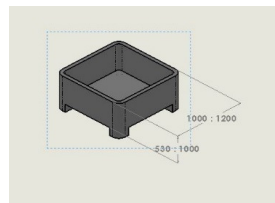

- Supplement for attachment FEM 2
- Supplement for attachment FEM 3
- Supplement for double attachment FEM 2 and FEM 3
- Supplement for attachment on tractor agricultural forklift

- * Pichforkable shoe-horns
- * Supplement for folding forks



PRICES EURO

HYDRAULIC SIDE-TIPPER WITH HYDRAULIC ARM AND FEM PLATE



Suitable for any agricultural and industrial forklift
 With sequence valve, which allows blocking and overturning with a single lever

The standard length of the FEM plate is 1000 mm.

- Max nominal capacity load kg.1500
- Max overturning capacity load kg.700
- Closing min. 530 mm. max. 780 mm.
- Weight kg. 290

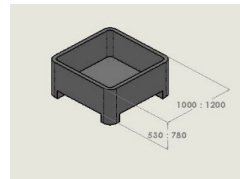

- Max nominal capacity load kg.1500
- Max overturning capacity load kg.700
- Closing min. 780 mm. max. 1000 mm.
- Weight kg. 299

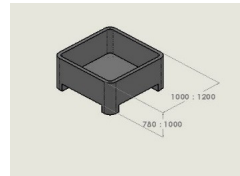

- Max nominal capacity load kg.1500
- Max overturning capacity load kg.700
- Closing min. 530 mm. max. 1000 mm.
- Weight kg. 310

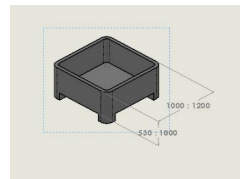

- Supplement for attachment FEM 2-Supplement for attachment FEM 2-
- Supplement for attachment FEM 2
- Supplement for attachment FEM 3
- Supplement for double attachment FEM 2 abd FEM 3
- Supplement for FEM plate length 1200 mm.
- * Pichforkable shoe-homs



PRICES EURO

HYDRAULIC SIDE TIPPER WITH 360° CONTINUOUS-BILATERAL ROTATION



WITH HYDRAULIC BINS-HOLDER ARM

With sequence valve, which allows blocking and overturning with a single lever

- Max nominal capacity load kg.1300
- Max overturning capacity kg.700
- Closing min. 530 mm. max. 780 mm.
- Closing min. 780 mm. max. 1000 mm.
- Closing min. 530 mm. max. 1000 mm.

PRICES EURO



WITH GRIP SYSTEM

With sequence valve, which allows blocking and overturning with a single lever

- Max nominal capacity kg.1300
- Max overturning capacity kg.700
- Closing min. 390 mm. max. 730 mm.
- Closing min. 730 mm. max. 1070 mm.
- Closing min. 400 mm. max. 1020 mm.
- Supplement for attachment FEM 2
- Supplement for attachment FEM 3-Supplement for attachment FEM 3-Supplement for attachment FEM 3-Supplement for attachment FEM 3
- Supplement for double attachment FEM 2 E FEM
- * Pichforkable shoe-homs
- * Supplement for folding forks

PRICES EURO



Suitable for any tractor's forklift and for any forklift

HYDRAULIC SIDE TIPPER WITH MRS



Suitable for any agricultural and industrial forklift
 With sequence valve, which allows blocking and overturning with a single lever

- Max nominal capacity load kg.1500
- Max overturning capacity load kg.750
- Closing min. 390 mm. max. 730 mm.
- Weight kg.285

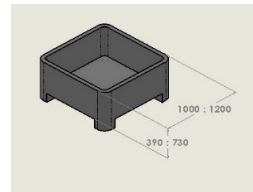

- Max nominal capacity load kg.1500
- Max overturning capacity load kg.750
- Closing min. 730 mm. max. 1070 mm.
- Weight kg.293

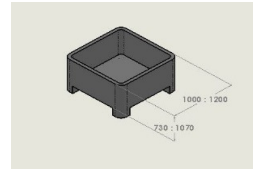

- Max nominal capacity load kg.1500
- Max overturning capacity load kg.750
- Closing min. 400 mm. max. 1020 mm.
- Weight kg.293

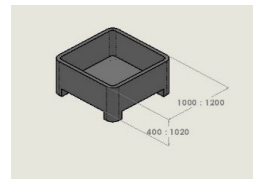

- Supplement for attachment FEM 2
- Supplement for attachment FEM 3
- Supplement for double attachment FEM 2 and FEM 3
- Supplement for attachment on tractor agricultural forklift

* Pichforkable shoe-horns

* Supplement for folding forks

* Supplement for folding lugs on load holder



PRICES EURO

** MEASURES OF LOCKING BINS / CONTAINER CAN BE PERSONALISED
 ACCORDING TO CUSTOMER REQUIREMENTS.
 STAINLESS STEEL VERSIONS AVAILABLE ON REQUEST

HYDRAULIC BUCKET WITH COUPLING:

- a) FOR FORKLIFT TRUCKS
- b) FOR 3 POINTS LINKAGE
- c) FOR FORKLIFT AND FOR 3 POINTS LINKAGE (SEE THE SUPPLEMENT)
(TO SPECIFY WHEN PASSING THE ORDER)



MOD.	CAPACITY Lt.	WIDTH mm.	CYLINDERS Nr.	WEIGHT Kg.	PRICES EURO
BIA 400	400	1.150	2	250	
BIA 450	450	1.350	2	270	
BIA 550	550	1.550	2	285	
BIA 600	600	1.750	2	315	
BIA 700	700	1.950	2	360	

OVERSIZE MODEL

MOD.	CAPACITY Lt.	WIDTH mm.	CYLINDERS Nr.	WEIGHT Kg.	PRICES EURO
BIA 580 M	580	1.150	2	295	
BIA 680 M	680	1.350	2	320	
BIA 780 M	780	1.550	2	370	
BIA 880 M	880	1.750	2	406	
BIA 1000 M	1.000	1.950	2	433	
BIA 1700 M	1.700	2.200	2	605	

Supplement for double attachment: for forklift + 3 points linkage
 Supplement for double attachment: for forklift + 3 points linkage
 Supplement for double attachment: for forklift + 3 points linkage
 Supplement for double attachment: for forklift + 3 points linkage

Supplement for attachment on tractor agricultural forklift different from E.L.S.
 Supplement for attachment on tractor agricultural forklift different from E.L.S.
 Supplement for attachment on tractor agricultural forklift different from E.L.S.
 Supplement for attachment on tractor agricultural forklift different from E.L.S.
 Supplement for attachment FEM 2
 Supplement for attachment FEM 2
 Supplement for attachment FEM 2
 Supplement for attachment FEM 2
 Supplement for attachment FEM 3
 Supplement for attachment FEM 3
 Supplement for attachment FEM 3
 Supplement for attachment FEM 3

PRICES EURO

HYDRAULIC BUCKET TO BE APPLIED ON THE FORKS



MOD.	CAPACITY Lt.	WIDTH mm.	WEIGHT Kg.	PRICES EURO
1 cylinder				
BII 400	400	1.150	245	
BII 450	450	1.350	278	
BII 550	550	1.550	302	
2 cylinders				
BII 600	600	1.750	330	
BII 700	700	1.950	360	

OVERSIZE VERSION

MOD.	CAPACITY Lt.	WIDTH mm.	WEIGHT Kg.	PRICES EURO
1 cylinder				
BII 580 M	580	1.150	295	
BII 680 M	680	1.350	350	
2 cylinder				
BII 780 M	780	1.550	365	
2 cylinder				
BII 1000 M	1.100	2.000	510	

BACKHOES

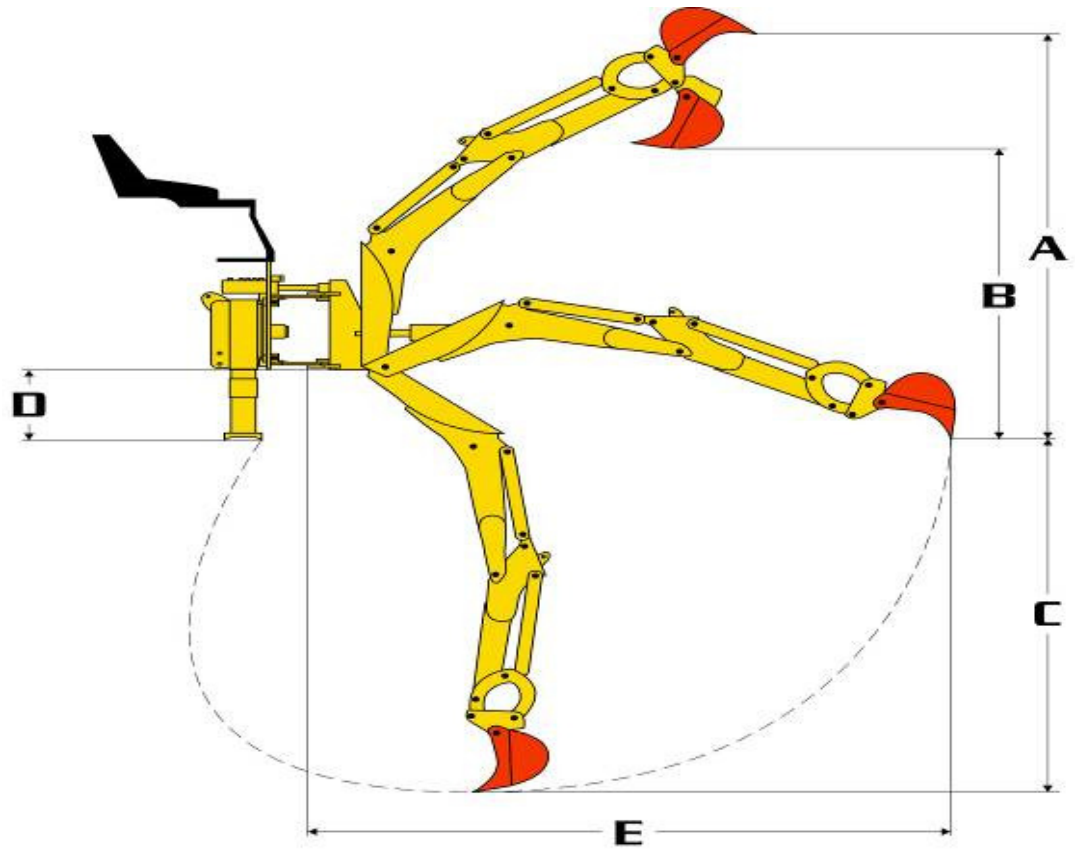

		E15	F19	F20	F23	F24	F25	F28	F30	F36
			E19	E20	E23	E24	E25	E28	E30	E36
A	mm.	1600	2350	2450	2750	3550	2950	3400	3500	4400
B	mm.	1300	1600	1850	2150	2750	2350	2450	2500	3380
C	mm.	1450	1900	2000	2280	2380	2500	2850	3050	3650
D	mm.	300	250	450	550	400	550	550	550	550
E	mm.	2500	2550	3000	3250	3400	3450	3680	3900	4850
Side shift	mm.	NO	YES	YES	YES	YES	YES	YES	YES	YES
Rotation		140°	180°	180°	180°	180°	180°	180°	180°	180°
Tearing power	Kg.	1200	2000	2600	2600	2600	2600	3200	3200	4300
Bucket width	mm.	250	300	300	400	300	400	400	400	500
Total width	mm.	1000	1000	1200	1200	1200	1600	1600	1600	1800
Operating pressure	bar	170	170	170	170	170	170	170	170	170
Tank capacity	liters	12	12	34	34	34	45	45	45	70
Weight without oil	Kg.	208	327	562	604	568	680	750	790	1518
Weight with oil	Kg.	223	342	601	643	607	744	814	854	1623
For tractor HP	CV	from 15 to 25	from 20 to 30	from 40 to 70	from 50 to 70	from 50 to 80	from 50 to 90	from 70 to 90	from 70 to 90	from 90 to 200



MODEL E 15

STANDARD EQUIPMENT

- Hydraulic independent stabilizer feet
- 140° rotation with one cylinder
-
- Six elements distributor equipped with joystick control

- Stationary arm no side-shift
-
- 3 point linkage and seat for tractor applications

- Ground bucket mm.250
- Hydraulic set pump, multiplier and hoses
- Demountable seat no flexible
- Delivered without oil

PRICE EURO:

MODEL	PRICES EURO
F 19 with bucket mm.300 including pump kit and gearbox	
F 20 with bucket mm.300 including pump kit and gearbox	
F 23 with bucket mm.400 including pump kit and gearbox	
F 24 with bucket mm.300 including pump kit and gearbox	
F 25 with bucket mm.400 including pump kit and gearbox	
F 28 with bucket mm.400 including pump kit and gearbox	
F 30 with bucket mm.400 including pump kit and gearbox	
F 36 with bucket mm.500 including pump kit and gearbox	

ACCESSORIES	PRICES IN EURO
TELESCOPIC ARM	
- Traditional (tubular) model F/E 25-28-30 lengthening mm. 450	
- Industrial model F/E 36	
FLEXIBLE SEAT	

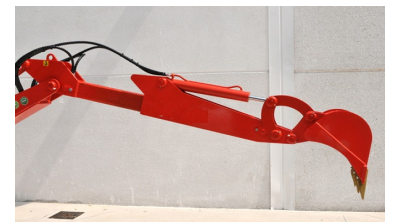

ACCESSORIES	PRICES EURO
COUPLE ARMS TO BLOCK THE 3 POINT LINKAGE WITH COUPLE PINS FOR ARMS APPLICATION	
for models E15 E/F19	
for other models	



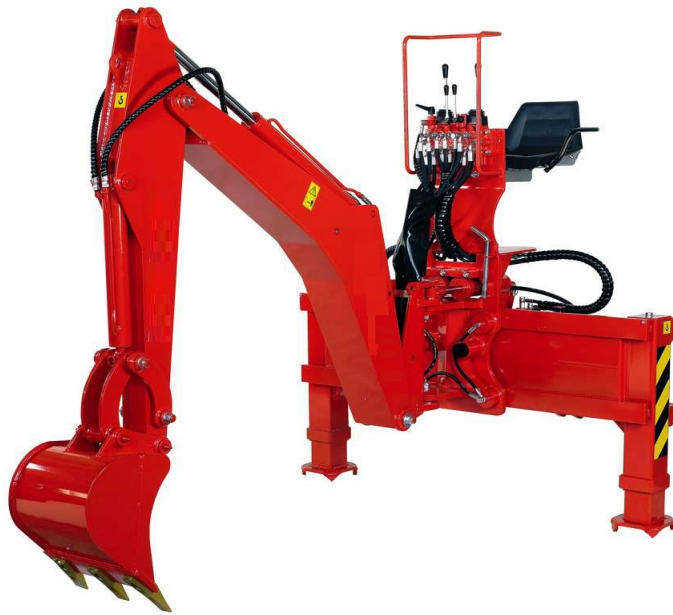

STANDARD EQUIPMENT "F" MODELS

- Hydraulic independent stabilizer feet
- 180° rotation with two cylinders
- Six elements distributor equipped with cavitation-proof and shock-proof valves (mod. F24 shock-proof) and **joystick control**
- Side-shift arm with **hydraulic locking**
- Articulated on cemented bushes and hardened pins
- 3 point linkage and seat for tractors applications or connecting plate for industrial attachment
- Ground bucket
- Demountable seat no flexible
- Delivered without oil



MODEL	PRICES EURO
E 19 with bucket mm.300 including pump kit and gearbox	
E 20 with bucket mm.300 including pump kit and gearbox	
E 23 with bucket mm.400 including pump kit and gearbox	
E 24 with bucket mm.300 including pump kit and gearbox	
E 25 with bucket mm.400 including pump kit and gearbox	
E 28 with bucket mm.400 including pump kit and gearbox	
E 30 with bucket mm.400 including pump kit and gearbox	
E 36 with bucket mm.500 including pump kit and gearbox	

ACCESSORIES	PRICES EURO
<p>TELESCOPIC ARM</p> <ul style="list-style-type: none"> - Traditional (tubular) model F/E 25-28-30 lengthening mm. 450 - Industrial model F/E 36 <p>FLEXIBLE SEAT</p>	

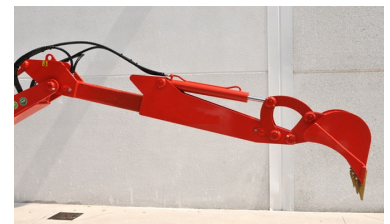

ACCESSORIES	PRICES EURO
<p>COUPLE ARMS TO BLOCK THE 3 POINT LINKAGE WITH COUPLE PINS FOR ARMS APPLICATION</p> <p>for models E15 E/F19</p> <p>for other models</p>	



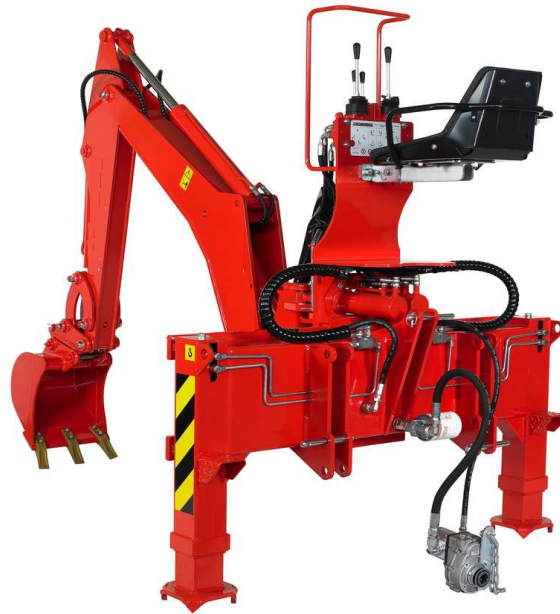

STANDARD EQUIPMENT "E" MODELS

- Hydraulic independent stabilizer feet
- 180° rotation with two cylinders
- Six elements distributor equipped with shock-proof valves (except mod. E19) with **joystick control**
- Side-shift arm with **mechanical locking**
- Articulated on cemented bushes and hardened pins
- 3 point linkage and seat for tractors applications or connecting plate for industrial attachment
- Ground bucket
- Demountable seat no flexible.
- Delivered without oil

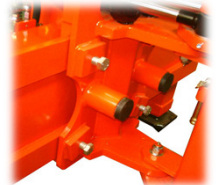



DIGGING BUCKET



E15

WIDTH mm.	TEETH NUMBER	WEIGHT Kg.	CAPACITY Lt.	PRICES EURO
200	2	10	10	
250	3	11	12	
300	3	12	14	

F/E 19

WIDTH mm.	TEETH NUMBER	WEIGHT Kg.	CAPACITY Lt.	PRICES EURO
200	2	20	10	
300	3	25	16	
400	3	32	23	
500	4	37	30	

F/E 20 - F/E 23 - F/E 24 - F/E 25 - F/E 28 - F/E 30

WIDTH mm.	TEETH NUMBER	WEIGHT Kg.	CAPACITY Lt.	PRICES EURO
200	2	23	11	
300	3	28	18	
400	3	34	25	
500	4	39	32	
600	4	44	38	

F/E 36

WIDTH mm.	TEETH NUMBER	WEIGHT Kg.	CAPACITY Lt.	PRICES EURO
300	3	49	26	
400	3	54	35	
500	4	60	43	
600	4	67	52	

DITCHES CLEANING BUCKET



E15

WIDTH mm.	WEIGHT kg.	CAPACITY Lt.	PRICES EURO
400	22	19	
500	24	24	
600	26	28	

F/E 19

WIDTH mm.	WEIGHT kg.	CAPACITY Lt.	PRICES EURO
600	42	42	
700	45	46	
800	48	52	

F/E 20 - F/E 23 - F/E 24 - F/E 25 - F/E 28 - F/E 30

WIDTH mm.	WEIGHT kg.	CAPACITY Lt.	PRICES EURO
700	50	47	
800	52	53	
1.000	57	67	

F/E 36

WIDTH mm.	WEIGHT kg.	CAPACITY Lt.	PRICES EURO
800	52	61	
1.000	72	76	
1.200	83	98	

PIVOTING DITCHES CLEANING BUCKET



F/E 19

WIDTH mm.	WEIGHT kg.	CAPACITY Lt.	PRICES EURO
800	68	65	
1.000	80	70	

F/E 20 - F/E 23 - F/E 24 - F/E 25 - F/E 28 - F/E 30

WIDTH mm.	WEIGHT kg.	CAPACITY Lt.	PRICES EURO
800	75	53	
1.000	84	67	
1.200	94	80	

F/E 36

WIDTH mm.	WEIGHT kg.	CAPACITY Lt.	PRICES EURO
1.200	141	98	
1.400	150	121	

TRAPEZOID BUCKET



E 15 F/E 19 F/E 20 - F/E 23 - F/E 24 - F/E 25 - F/E 28 - F/E 30 F/E 36	PRICES EURO

GRIPPER

model M with mechanical rotator



MODEL	WEIGHT Kg.	F/E 19 - CAPACITY Kg.	PRICES EURO
M 01	65	400	
MODEL	WEIGHT Kg.	F/ E 20 - F/E 23 - F/E 24 - F/E 25 - F/E 28 - F/E 30 CAPACITY Kg.	PRICES EURO
M 02	70	400	

model R with standard hydraulic rotator



MODEL	WEIGHT Kg.	E 15 CAPACITY Kg.	PRICES EURO
R 08	24	600	
MODEL	WEIGHT Kg.	CAPACITY Kg.	PRICES EURO
R 08	24	600	
R 16	48	1200	
MODEL	WEIGHT Kg.	F/ E 20 - F/E 23 - F/E 24 - F/E 25 - F/E 28 - F/E 30 CAPACITY Kg.	PRICES EURO
R 16	48	1200	
R 22	95	1600	
MODEL	WEIGHT Kg.	F/E 36 CAPACITY Kg.	PRICES EURO
R 30	180	2500	

SUPPLEMENT for Hydraulic rotator power supply
 the capacity apply to the nominal machinery capacity and not
 to the backhoe capacity where it will be attached.

BUCKET TEETH



F/ E 20 - F/E 23 - F/E 24 - F/E 25 - F/E 28 - F/E 30

MODEL	WEIGHT Kg.	NR. TEETH	PRICES EURO
D3		3 TEETH	
D4		4 TEETH	

PIN-TO-PIN QUICK COUPLERS

ACCESSORIES	PRICES EURO
QUICK COUPLERS FOR BUCKET PIN OF DIAM. 25 UP TO 1,8 TON.	
QUICK COUPLERS FOR BUCKET PIN OF DIAM. 30 UP TO 2,5 TON.	
QUICK COUPLERS FOR BUCKET PIN OF DIAM. 35 UP TO 4 TON.	
QUICK COUPLERS FOR BUCKET PIN OF DIAM. 40 UP TO 4 TON.	

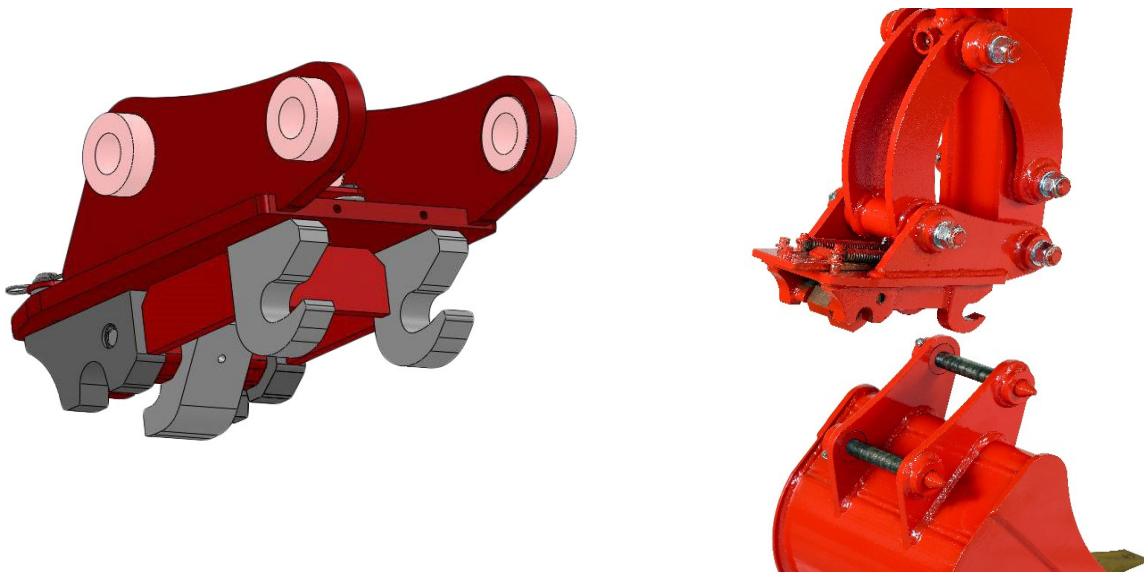

The quick couplers for bucket series EASY 25 - 30 - 35 -40 allows the connection and disconnection of all the equipments in a few seconds with great saving of time and an absolute risk reduction of accidents in the tool change. It has particular characteristics that make it ideal coupler for mini-excavators.

The possibility to be mounted on original buckets.

It has a radius reduced of digging, as a consequence it has a maximal pull force of the excavator.

The quick couplers for bucket are semiautomatic to speed the digging operations.

Double safety system with springs and mechanical safety catch inserted by the operator for the highest security.

The high quality material, wear -resistant, all of the most stressed parts are in Hardox 400 material to ensure the highest performances and to keep them unchanged over time.

The highest flexibility, because the Industrial E.L.S. quick couplers can be adapted for any excavator and for every kind of coupling on the equipments.

Interchangeability with the original, the Industrial E.L.S. coupling can be mounted on excavators using the originals coupling pins of the machine and for this reason ensure the highest interchangeability and performance of the originals equipments.

AUGER DRILL

HEAD FOR AUGER DRILL WITH ALL CONNECTIONS	MAX OILFLOW RATE	SHAFT SIZE	MAX PRESSURE	PRICES EURO
TST 1 ESCAVATORS FROM 1 TO 2 TON	40 LT./MIN.	HEXAGONAL 50	BAR 200	
TST 2 ESCAVATORS FROM 2 TO 3,5 TON	60 LT./MIN.	HEXAGONAL 50	BAR 200	
TST 3 ESCAVATORS FROM 3,5 TO 5 TON	75 LT./MIN	HEXAGONAL 50	BAR 250	
TST 4 ESCAVATORS FROM 6 TO 12 TON	125 LT./MIN	HEXAGONAL 50	BAR 250	
TST 4 ESCAVATORS FROM 6 TO 12 TON	125 LT./MIN	HEXAGONAL 70	BAR 250	
TST 5 ESCAVATORS FROM 12 TO 18 TON	125 LT./MIN	HEXAGONAL 70	BAR 250	

DRILL BIT WITH BLADE AND CLEANING HOLE BRUSH HEXAGONAL COUPLING MM.50

MODEL	DIAMETER MM.	LENGHT MM.	PRICES EURO
TR80	80	1.000	
TR100	100	1.000	
TR150	150	1.000	
TR180	180	1.000	
TR200	200	1.000	
TR250	250	1.000	
TR300	300	1.000	
TR400	400	1.000	
TR500	500	1.000	

SUPPLEMENT FOR COUPLING WITH KEY OF 70 MM.

ACCESSORIES	PRICES EURO
SUPPLEMENT FOR DOUBLE ARTICULATION	
SUPPLEMENT FOR TEETH WITH CAPSULE AND SPIRAL BITS FROM DIAM. 200	
SUPPLEMENT FOR ROUND SHANK PICKS CEMENTED TUNGSTEN CARBIDE FOR ROCKY SOIL FOR DRILL UP TO DIAM. 300 FOR DRILL UP TO DIAM. 350-400 FOR DRILL UP TO DIAM. 450-500	

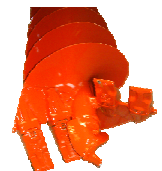

COUPLING OF 50 MM. COMPLETE WITH STEEL SPIRAL

FOR MOD. TR150 - TR200 - LENGHT MM.1000
FOR MOD. TR250 - TR300 - LENGHT MM.1000
FOR MOD. TR400 - TR500 - LENGHT MM.1000
SUPPLEMENT FOR COUPLING WITH KEY OF 70 MM.

PRICES EURO

EXTENTION WITH HEXAGONAL COUPLING OF 50 MM. WITHOUT STEEL SPIRAL

FOR MOD. TR150 - TR200 - TR250 - TR300 - LENGHT MM.1000
FOR MOD. TR400 - TR500 - LENGHT MM.1000
SUPPLEMENT FOR COUPLING WITH KEY OF 70 MM.

PRICES EURO

SPARE PARTS FOR AUGER DRILL

KEY CONNECTION
FEMALE EXCLUDED PLATE
DIAMETER MM. 50
DIAMETER MM. 70
TEETH

SPIRAL SUPPORT DIAM. 64 MM.
SPIRAL DIAM. 64 MM.

SPIRAL SUPPORT DIAM. 89 MM.
SPIRAL DIAM.89 MM.

SPIRAL SUPPORT DIAM. 115 MM.
SPIRAL DIAM.115 MM.

PICKS 42 MODEL

PRICES EURO



SCREW WOOD SPLITTER

HEAD FOR SCREW WOOD SPLITTER WITH ALL CONNECTIONS	MAX OILFLOW RATE	MAX PRESSURE	PRICES EURO
SPT1	15-35 LT./MIN.	230	
SPT2	40-60 LT./MIN.	250	
SPT3	66-75 LT./MIN.	250	

The above prices are for the head only, you need to add the price of the screw wood splitter from the table below



SCREW WOOD SPLITTER WITH ALL CONNECTIONS



SCREW WOOD SPLITTER
SCREW WOOD SPLITTER DIAMETER 140 WITHOUT HEXAGONAL BUSHING
SCREW WOOD SPLITTER DIAMETER 140 WITH HEXAGONAL BUSHING
SCREW WOOD SPLITTER DIAMETER 140 WITH HEXAGONAL BUSHING 70
SCREW WOOD SPLITTER DIAMETER 170 WITHOUT HEXAGONAL BUSHING
SCREW WOOD SPLITTER DIAMETER 170 WITH HEXAGONAL BUSHING 50
SIRIO SCREW WOOD SPLITTER DIAMETER 170 WITH HEXAGONAL BUSHING 70

PRICES EURO





SPARE PART
Metal point spare part

PRICES EURO

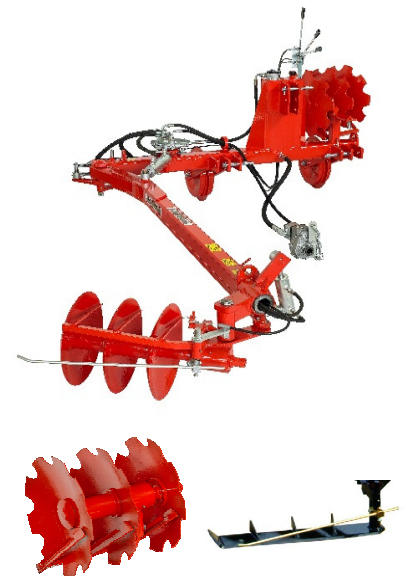
**IN AND OUT
TREE
CULTIVATORS**

**HYDRAULIC DISC CULTIVATOR
WITH SIDE ARM AND 3-POINTS LINKAGE, SUPPLIED WITH HYDRAULIC PUMP + GEARBOX,
TANK WITH FILTER**



MODEL	PRICES EURO
<p>ECOL. LAT. 3P</p> <p>3 ROUND DISKS 3 TOOTHED DISKS 4 ROUND DISKS 4 TOOTHED DISKS WEEDER BLADE INCLUDED OF RETURN ARM AND WHEEL SUPPORT TREES-CLEANING BLADE 3-POINT HYDRAULIC WITH HOSES AND QUICK COUPLING CONNECTIONS SUPPLEMENT for KIT WHEEL SUPPORT INCLUDED OF RETURN ARM SUPPLEMENT for motorization on round disks SUPPLEMENT for electrohydraulic model</p> <p>KIT WEEDER BLADE supplied apart included of return arm and wheel support</p> <p>WEEDER BLADE only without return arm and without slide or wheel support</p> <p>SUPPLEMENT for the last removable disk</p> <p>SWEEPER (reccomended with kit wheel support complete with return arm)</p> <p>GRASS-CUTTER DISK (reccomended with kit wheel support complete with return arm)</p>	   

CULTIVATOR TO BE COMBINED WITH OTHERS EQUIPMENT WITH ELECTROHYDRAULIC SYSTEM AND PUSH-BUTTON CONTROL



MODEL	PRICES EURO
<p>ECOL. COMB. EI LA</p> <p>WEEDER BLADE</p> <p>Supplied standard with 2 hoses with quick couplings connections (the tractor must have 2 quick oil settings and 1 lever simple effect)</p>	
<p>ECOL. COMB. EI LA INC</p> <p>WEEDER BLADE</p> <p>DISKS PREDISPOSITION</p> <p>Supplied in this version with 4 hoses with quick couplings (the tractor must have 4 quick settings and 1 lever d/e and 1 s/e)</p>	
<p>ECOL. COMB. EI DI / DI LA</p> <p>3 ROUND DISKS</p> <p>3 TOOTHED DISKS</p> <p>4 ROUND DISKS</p> <p>4 TOOTHED DISKS</p> <p>WEEDER BLADE</p> <p>Supplied in this version with 4 hoses with quick couplings (the tractor must have 4 quick settings and 1 lever d/e and 1 s/e)</p>	
<p>KIT TANK- PUMP AND MULTIPLIER</p> <p>for independt working with tractor' s P:T:O</p>	
<p>SUPPLEMENT for the last removable disk</p>	

**The technical characteristics are indicative and in no way binding.
The prices and technical characteristics could change at any moment,
without prior notice.**

**Prices are ex works, taxes excluded.
Packing not included**
